



LMX-1202G-SFP Series

12-Port Industrial Gigabit Light Layer 3 Managed Ethernet Switch, with
10*10/100/1000Tx and 2*100/1000 SFP Slots



Hardware Manual

Version 2.0
(December 2020)



© Copyright 2020 Antaira Technologies, LLC

All rights reserved

This document contains information, which is protected by copyright. Reproduction, adaptation, or translation without prior permission is prohibited, except as allowed under the copyright laws.

Trademark Information

Antaira is a registered trademark of Antaira Technologies, LLC, Microsoft Windows and the Windows logo are the trademarks of Microsoft Corp. NetWare is the registered trademark of Novell Inc. WMM and WPA are the registered trademarks of Wi-Fi Alliance. All other brand and product names are trademarks or registered trademarks of their respective owners.

Notice: Copyrights © 2020 by Antaira Technologies, LLC. All rights reserved. Reproduction, adaptation, or translation without prior permission of Antaira Technologies, LLC is prohibited, except as allowed under the copyright laws.

Disclaimer

Antaira Technologies, LLC provides this manual without warranty of any kind, expressed or implied, including but not limited to the implied warranties of merchantability and fitness for a particular purpose. Antaira Technologies, LLC may make improvements and/or changes to the product and/or specifications of the product described in this manual, without prior notice. Antaira Technologies, LLC will not be liable for any technical inaccuracies or typographical errors found in this guide. Changes are periodically made to the information contained herein and will be incorporated into later versions of the manual. The information contained is subject to change without prior notice.

FCC Warning

This equipment has been tested and found to comply with the limits for a Class-A digital device, pursuant to Part 15 of the FCC rules. These limits are designed to provide reasonable protection against harmful interference in a residential installation. This equipment generates, uses, and can radiate radio frequency energy. It may cause harmful interference to radio communications if the equipment is not installed and used in accordance with the instructions. However, there is no guarantee that interference will not occur in a particular installation. If this equipment does cause harmful interference to radio or television reception, which can be determined by turning the equipment off and on, the user is encouraged to try to correct the interference by one or more of the following measures:

- Reorient or relocate the receiving antenna.
- Increase the separation between the equipment and receiver.
- Connect the equipment into an outlet on a circuit different from that to which the receiver is connected.
- Consult the dealer or an experienced radio/TV technician for help.

Caution: Any changes or modifications not expressly approved by the grantee of this device could void the user's authority to operate the equipment.

Avertissement FCC

Cet équipement a été testé et déclaré conforme aux limites d'un appareil numérique de classe A, conformément à la partie 15 des règles de la FCC. Ces limites sont conçues pour fournir une protection raisonnable contre les interférences nuisibles dans une installation résidentielle. Cet équipement génère, utilise et peut émettre de l'énergie radiofréquence. Cela peut provoquer des interférences nuisibles aux communications radio si l'équipement n'est pas installé et utilisé conformément aux instructions. Cependant, il n'y a aucune garantie qu'aucune interférence ne se produira dans une installation particulière. Si cet équipement provoque des interférences nuisibles à la réception radio ou télévision, ce qui peut être déterminé en éteignant puis en rallumant l'équipement, l'utilisateur est encouragé à essayer de corriger les interférences par une ou plusieurs des mesures suivantes:

- Réorientez ou déplacez l'antenne de réception.
- Augmentez la distance entre l'équipement et le récepteur.
- Connectez l'équipement à une prise sur un circuit différent de celui auquel le récepteur est connecté.
- Consultez le revendeur ou un technicien radio / TV expérimenté pour obtenir de l'aide.

CE Mark Warning

This is a Class-A product. In a domestic environment, this product may cause radio interference in which case the user may be required to take adequate measures.

Avertissement de marque CE

Ceci est un produit de classe A. Dans un environnement domestique, ce produit peut provoquer des interférences radio, auquel cas l'utilisateur peut être amené à prendre des mesures adéquates.

ATEX Certification

ATEX Marking String:  II 3G Ex nA nC IIC T4 Gc

ATEX Certificate No.: DEMKO 18 ATEX 2104X

Standards: EN 60079-0:2012 + A11:2013, EN 60079-15:2010

Temperature code: T4

Specific Conditions of Use

- The equipment shall be installed in an enclosure that provides a degree of protection not less than IP 54 in accordance with EN 60079-15 and accessible only by the use of a tool. In addition, the equipment shall only be used in an area of not more than pollution degree 2 as defined in EN 60664-1.
- Provisions shall be made to prevent the rated voltage from being exceeded by transient disturbances of more than 140%.
- Conductors suitable for use in an ambient temperature of 105.7°C must be used for the power supply terminal.
- The external grounding conduct shall be at least 4 mm².

WARNING: EXPLOSION HAZARD - Do not disconnect while the circuit is live or unless the area is free of ignitable concentrations.

Industrial Ethernet Switches

Industrial Grade Managed Ethernet Switches

Hardware Manual

Version 2.0 (December 2020)

The manual supports the following models:

- LMX-1202G-SFP
- LMX-1202G-SFP-T

This document is the current official release hardware manual. Please check our website (www.antaira.com) for any updated manual or contact us by e-mail (support@antaira.com).

Table of Contents

| | |
|------------------------------------|-----------|
| 1 Overview | 1 |
| 1.1 Product Hardware Features | 1 |
| 1.2 Product Software Features | 2 |
| 1.3 Package Contents | 2 |
| 1.4 Safety Precaution | 3 |
| 2 Hardware Description | 4 |
| 2.1 Physical Dimensions | 4 |
| 2.2 Front View Panel | 5 |
| 2.3 Top View Panel | 6 |
| 2.4 LED Indicators | 6 |
| 2.5 Reset Button | 7 |
| 2.6 Ethernet Ports | 8 |
| 2.7 Cabling | 9 |
| 2.8 Wiring the Power Inputs | 9 |
| 2.9 Wiring the Fault Alarm Contact | 10 |
| 2.10 Grounding Note | 11 |
| 3 Mounting Installation | 12 |
| 3.1 DIN-Rail Mounting | 12 |
| 3.2 Wall Mounting | 13 |
| 4 Hardware Installation | 15 |
| 4.1 Installation Steps | 15 |
| 4.2 Maintenance and Service | 16 |
| 4.3 Troubleshooting | 16 |
| 5 Technical Specifications | 18 |

1 Overview

Antaira Technologies' LMX-1202G-SFP series is a 12-port industrial managed Ethernet switch that is embedded with 10*10/100/1000Tx Ethernet ports and 2*100/1000 SFP slots. The LMX-1202G-SFP series is a fully manageable light layer 3 Ethernet switch that is pre-loaded with a user-friendly web management console design. It supports the ring network redundancy function using the market's open standard ITU-T G.8032 ERPS (Ethernet Ring Protection Switch) protocol that has a <50ms network recovery time. The advanced network filtering and security functions, such as, IGMP, VLAN, QoS, SNMP, RMON, Modbus TCP, and 802.1X/ HTTPS/ SSH/ SSL increase determinism and improve network management for remote SCADA systems or control networks.

The LMX-1202G-SFP series is IP30 rated and DIN-rail mountable. There are also two wide operating temperature models for either a standard temperature range (STD: -10°C to 70°C) or an extended temperature range (EOT: -40°C to 75°C). It also provides high EFT and ESD protection for industrial networking applications, such as, power/utility, water wastewater, oil/gas/mining, factory automation, security surveillance within transportation, ITS and any other outdoor or harsh environment.

1.1 Product Hardware Features

System Interface and Performance

- All RJ45 ports support Auto MDI/MDI-X Function
- Embedded 10*10/100/1000Tx RJ45 ports and 2*100/1000 SFP slots
- Store-and-forward switching architecture
- 8K MAC address table
- Power line EFT protection: 2,000VDC; Ethernet ESD protection: 6,000VDC

Product Input

- DC 12~48V redundant, with a 6-pin removal terminal block
- The power input specification complies with the requirements of SELV (Safety Extra Low Voltage) and the power supply should comply with UL 61010-1 & UL 61010-2-201

Operating Temperature

- Standard operating temperature model: -10°C to 65°C
- Extended operating temperature model: -40°C to 75°C

Case / Installation

- IP30 protection metal housing
- DIN-Rail and wall-mount design

- Installation in a Pollution Degree 2 industrial environment

1.2 Product Software Features

Network Redundancy

- STP, RSTP, MSTP, ITU-T G.8032 Ethernet Ring Protection Switch (ERPS) for network redundancy

Network Management

- Web UI based management, SNMP v1/v2/v3, Serial Console
- QoS, traffic classification QoS, Cos, bandwidth control for Ingress and Egress, broadcast storm control, Diffserv
- IEEE 802.1q VLAN tagging, port-based VLAN support
- IGMP snooping v1/v2, IGMP filtering / throttling, IGMP query up to 256 group
- Supports IPv4/IPv6, RMON, MIB II, port mirroring, event syslog, DNS, NTP/SNTP, HTTPS, SSH/SSL, TFTP
- MODBUS TCP for SCADA system integration

Port Configuration

- Status, statistics, mirroring, rate limiting, event syslog

Event Handling

- Event notification by Email: Cold/Warm Start, Power Failure, Authentication, SNMP trap and Fault Alarm Relay Output

Storage Upgrade via TFTP and HTTP

Configuration Backup - USB Port

1.3 Package Contents

- LMX-1202G-SFP(-T)
- Quick Installation Guide
- Wall mounting bracket set with screws
- DC cable- 18AWG & DC jack 5.5 x 2.1mm
- RJ45 dust cover set
- RJ45 to DB9 serial console cable

1.4 Safety Precaution

Attention: If the DC voltage is supplied by an external circuit, please use a protection device on the power supply input. The industrial Ethernet switch's hardware specs, ports, cabling information, and wiring installation will be described within this hardware manual.

Attention: Si la tension CC est fournie par un circuit externe, veuillez utiliser un dispositif de protection sur l'entrée d'alimentation. Les spécifications matérielles, les ports, les informations de câblage et l'installation du câblage du commutateur Ethernet industriel seront décrits dans ce manuel d'utilisation.

Warning Labels

The caution label means that you should check certain information on the user manual when working with the device. (Shown in *Figure 1.1*)

Étiquettes d'avertissement

L'étiquette d'avertissement signifie que vous devez vérifier certaines informations du manuel d'utilisation lorsque vous travaillez avec l'appareil. (Illustré à la *figure 1.1*)



Figure 1.1 - Caution Label
Figure 1.1 - Étiquette de mise en garde



Figure 1.2 - Hot Surface Warning Label
Figure 1.2 - Étiquette d'avertissement de surface chaude

2 Hardware Description

2.1 Physical Dimensions

Figure 2.1, below, shows the physical dimensions of this product series:

(W x D x H) is 54mm x 99mm x 142mm

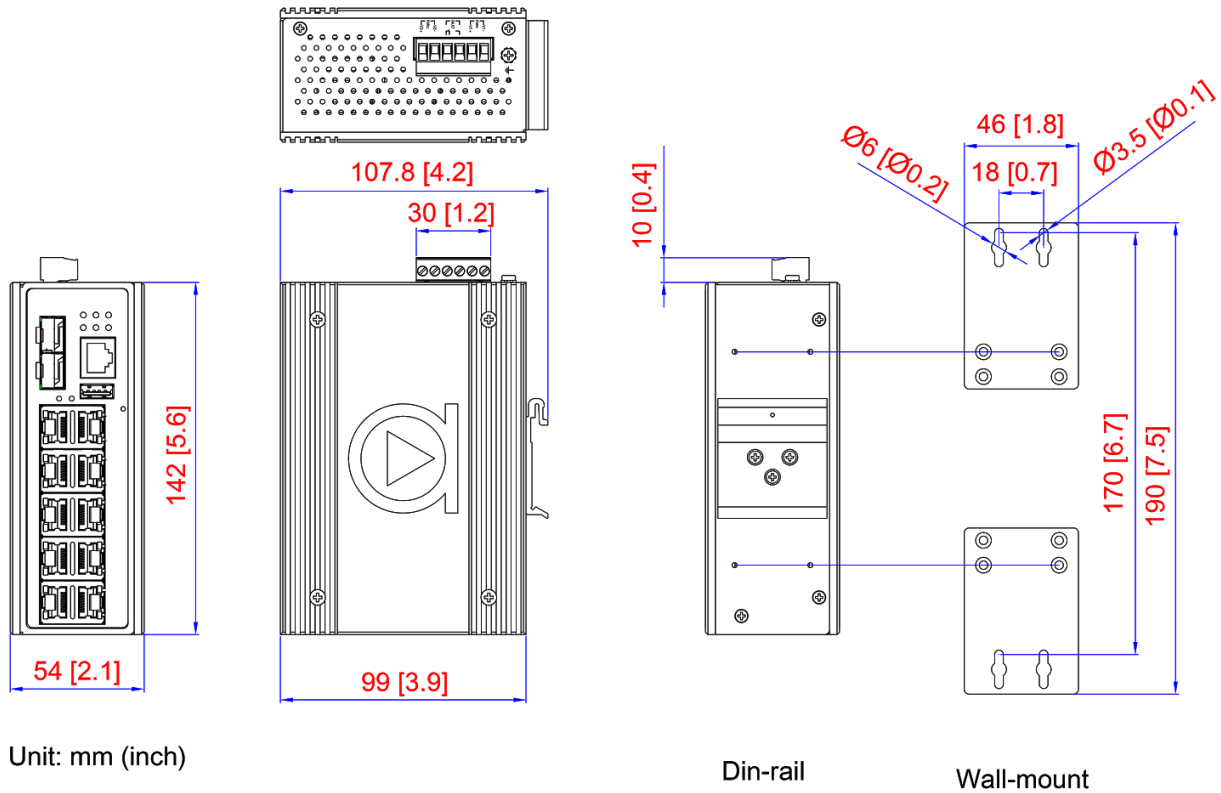

Figure 2.1 - Physical Dimensions

2.2 Front View Panel

Figure 2.2, below, shows the front panel of the product series:

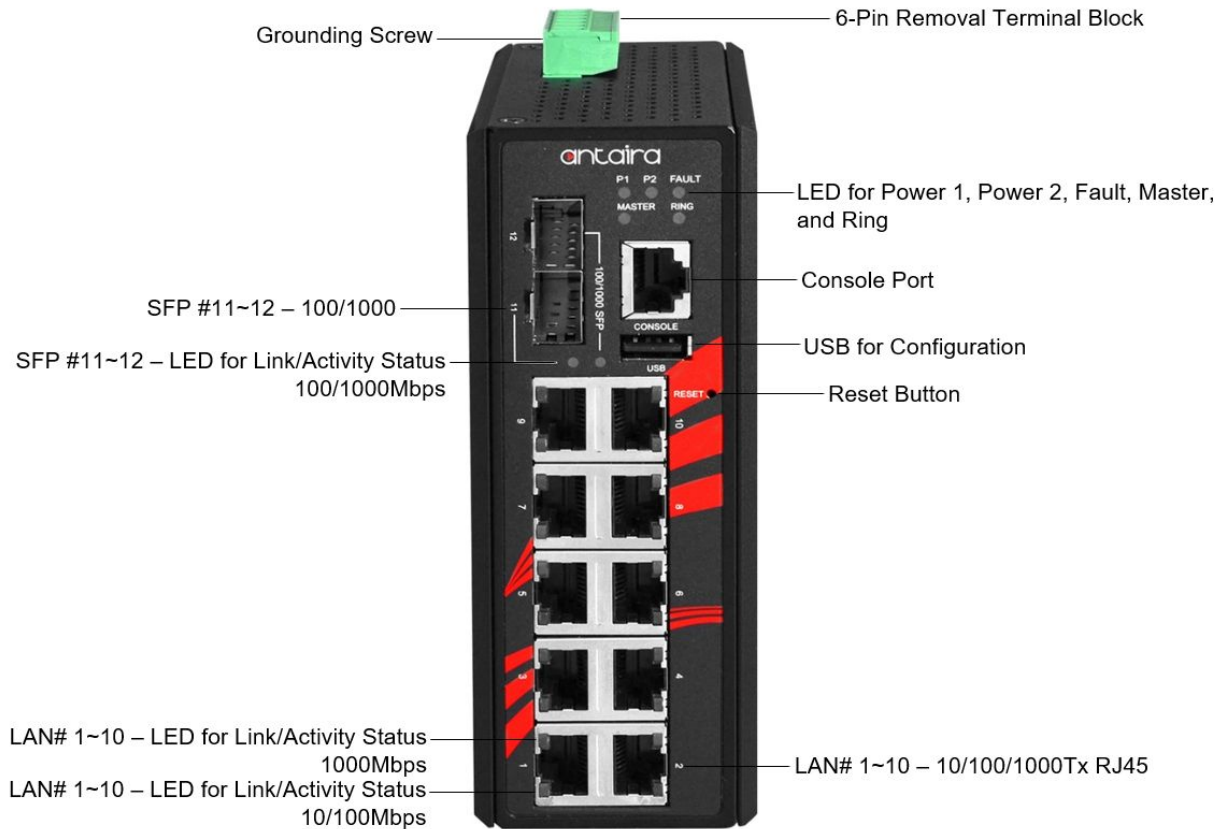

Figure 2.2 - Front View Panel



WARNING!

Airflow around the switch must be unrestricted. To prevent the switch from overheating, there must be the following minimum clearances:

- Top and bottom: 2.0 in (50.8 mm)
- Sides: 2.0 in (50.8 mm)
- Front: 2.0 in (50.8 mm)

2.3 Top View Panel

Figure 2.3, below, shows the top panel of the product series:

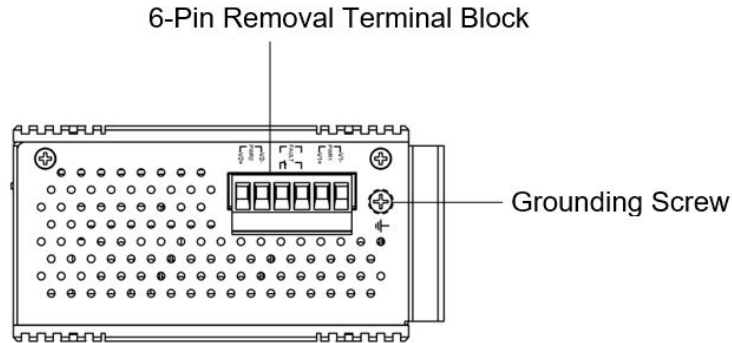

Figure 2.3 - Top View Panel

2.4 LED Indicators

There are LED light indicators located on the front panel of the industrial Ethernet switch that display the power status and network status. Each LED indicator has a different color and has its own specific meaning, see below in *Table 2.1*.

| LED | Color | Description | |
|--------|-------|-------------|--|
| P1 | Green | On | Power Input 1 is active |
| | | Off | Power Input 1 is inactive |
| P2 | Green | On | Power Input 2 is active |
| | | Off | Power Input 2 is inactive |
| Fault | Green | On | Power Input 1 or 2 is active |
| | | Off | Power off |
| | Red | On | Fault alarm is set and the condition is inactive |
| Master | Green | On | ERPS Owner Mode (Ring Master) is ready |
| | | Off | ERPS Owner Mode is not active |
| Ring | Green | On | Ring Network is active |
| | | Off | Ring Network is not active |



| | | | |
|------------------------------|--|----------|----------------------------------|
| LAN Port 1~10 (Upper LED) |  Green | On | Connected to network, 1000Mbps |
| | | Flashing | Networking is active |
| | | Off | Not connected to network |
| LAN Port 1~10 (Lower LED) |  Green | On | Connected to network, 10/100Mbps |
| | | Flashing | Networking is active |
| | | Off | Not connected to network |
| SFP Port 11~12 | Green | On | Connected to network, 1000Mbps |
| | | Flashing | Networking is active |
| | | Off | Not connected to network |
| | Amber | On | Connected to network, 100Mbps |
| | | Flashing | Networking is active |
| | | Off | Not connected to network |

Table 2.1 - LED Indicators

Note: "P1" is the abbreviation for "Power 1", "P2" is for "Power 2", "LNK" is for "Link", and "ACT" is for "Activity".

2.5 Reset Button

There is a "reset" button located on the top panel of the industrial Ethernet switch that helps users to reboot, restore default, or save running configurations by pressing the button for different seconds.

Please refer to Table 2.2 for the timing and function.

| Seconds | Function | Fault LED |
|--------------------------|---|--|
| 0s < t (press time) < 4s | Reboot the switch | LED is flashing with green color |
| 4s < t (press time) < 8s | Restore factory default | LED is flashing with green and red color |
| 8s < t (press time) | Backup configuration to USB (startup-config) | LED is flashing with red color |

Table 2.2 - Reset Button Functions

2.6 Ethernet Ports

- **RJ45 Ports**

RJ45 Ports (Auto MDI/MDI-X): The RJ45 ports are auto-sensing for 10Base-T, 100Base-TX, or 1000Base-T connections. Auto MDI means that the switch can connect to another switch or workstation without changing the straight-through or crossover cabling. See the figures below for straight-through and crossover cabling schematics.

- **RJ45 Pin Assignments**

| Crossover Cable | | Straight Through Cable | |
|---------------------|---------------------|------------------------|---------------------|
| Pin Number / Signal | Pin Number / Signal | Pin Number / Signal | Pin Number / Signal |
| 1 / RX+ | 3 / TX+ | 1 / RX+ | 1 / TX+ |
| 2 / RX- | 6 / TX- | 2 / RX- | 2 / TX- |
| 3 / TX+ | 1 / RX+ | 3 / TX+ | 3 / RX+ |
| 6 / TX- | 2 / RX- | 6 / TX- | 6 / RX- |

Table 2.2 - 10/100Base-T(X) RJ45 Pin Assignments

| Crossover Cable | | Straight Through Cable | |
|---------------------|---------------------|------------------------|---------------------|
| Pin Number / Signal | Pin Number / Signal | Pin Number / Signal | Pin Number / Signal |
| 1 / TP0+ | 3 / TP1+ | 1 / TP0+ | 1 / TP1+ |
| 2 / TP0- | 6 / TP1- | 2 / TP0- | 2 / TP1- |
| 3 / TP1+ | 1 / TP0+ | 3 / TP1+ | 3 / TP0+ |
| 4 / TP2+ | 7 / TP3+ | 4 / TP2+ | 4 / TP3+ |
| 5 / TP2- | 8 / TP3- | 5 / TP2- | 5 / TP3- |
| 6 / TP1- | 2 / TP0- | 6 / TP1- | 6 / TP0- |
| 7 / TP3+ | 4 / TP2+ | 7 / TP3+ | 7 / TP2+ |
| 8 / TP3- | 5 / TP2- | 8 / TP3- | 8 / TP2- |

Table 2.3 - 1000Base-T RJ45 Pin Assignments

Note: "+" and "-" signs represent the polarity of the wires that make up each wire pair.

2.7 Cabling

Use the four twisted-pair, category 5e, or the above cabling for the RJ45 port connections. The cable between the switch and the link partner (switch, hub, workstation, etc.) must be less than 100 meters (328 ft.) in length.

The small form-factor pluggable (SFP) is a compact optical transceiver used in optical communications for both telecommunication and data communication applications.



Caution: Please employ optional optical transceiver (SFP/Fixed Fiber) that complies with IEC-60825-1 and classified as Class 1 laser product.



Attention: Veuillez utiliser un émetteur-récepteur optique en option (SFP/fibre fixe) conforme à la norme IEC-60825-1 et classé comme produit laser de classe 1.

2.8 Wiring the Power Inputs



Caution: Please follow the steps below when inserting the power wire.



Attention: Veuillez suivre les étapes ci-dessous lors de l'insertion du câble d'alimentation.

1. Insert the positive and negative wires into the PWR1 (V1+, V1-) and PWR2 (V2+, V2-) contacts on the terminal block connector as shown below in *Figure 2.6*.

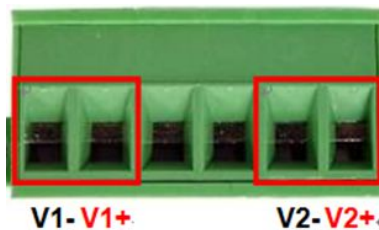

Figure 2.6 - Power Terminal Block

2. Tighten the wire-clamp screws to prevent the wires from loosening, as shown below in *Figure 2.7*.

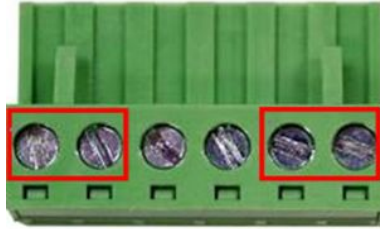

Figure 2.7 - Power Terminal Block



Caution:

Only use copper conductors, **125°C**, tighten to **5 lbs**.

The wire gauge for the terminal block should range between **18~20 AWG**.



Attention:

Utilisez uniquement des conducteurs en cuivre, **125°C**, serrez à **5 lb**.

Le calibre des fils du bornier doit être compris entre **18 et 20 AWG**.

2.9 Wiring the Fault Alarm Contact

The fault alarm contact is in the middle of the terminal block connector as the picture shows below in *Figure 2.8*. By inserting the wires, it will detect the fault status including power failure or port link failure (managed industrial switch only), and form a normal open circuit. An example is shown below in *Figure 2.8*.

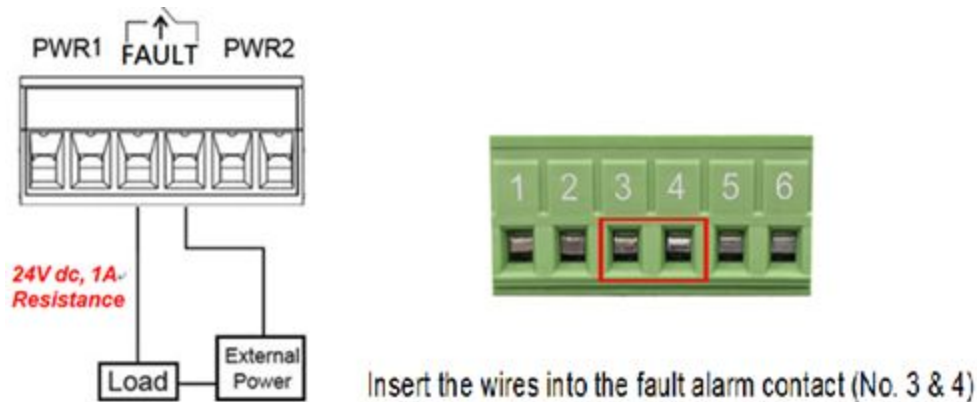

Figure 2.8 - Wiring the Fault Alarm Contact

Caution:



The wire gauge for the terminal block should range between 12 ~ 24 AWG.

If only using one power source, jumper Pin 1 to Pin 5 and Pin 2 to Pin 6 to eliminate power fault alarm.

Attention:



Le calibre des fils du bornier doit être compris entre 12 et 24 AWG.

Si vous n'utilisez qu'une seule source d'alimentation, connectez les broches 1 à 5 et les broches 2 à 6 pour éliminer l'alarme de panne de courant.

2.10 Grounding Note

Grounding and wire routing help limit the effects of noise due to Electromagnetic Interference (EMI). Run the ground connection from the ground screw to the grounding surface prior to connecting devices. The grounding screw symbol is shown below in *Figure 2.9*.

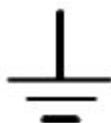

Figure 2.9 - Grounding screw symbol



Caution: Using a shielded cable achieves better electromagnetic compatibility.



Attention: L'utilisation d'un câble blindé permet une meilleure compatibilité électromagnétique

3 Mounting Installation

3.1 DIN-Rail Mounting

The DIN-Rail is pre-installed on the industrial Ethernet switch from the factory. If the DIN-Rail is not on the industrial Ethernet switch, please see *Figure 3.1* to learn how to install the DIN-Rail on the switch.

Follow the steps below to learn how to hang the industrial Ethernet switch:

1. Use the screws to install the DIN-Rail bracket on the rear side of the industrial Ethernet switch.



Caution: The torque for tightening the screws on the device is 3.5 in-lbs.



Attention: Le couple de serrage des vis sur l'appareil est de 3.5 pouces-livres.

2. To remove the DIN-Rail bracket, do the opposite from step 1.
3. After the DIN-Rail bracket is installed on the rear side of the switch, insert the top of the DIN-Rail on to the track as shown below in *Figure 3.2*.
4. Lightly pull down the bracket onto the rail as shown below in *Figure 3.3*.
5. Check if the bracket is mounted tightly on the rail.
6. To remove the industrial Ethernet switch from the rail, do the opposite from the above steps.

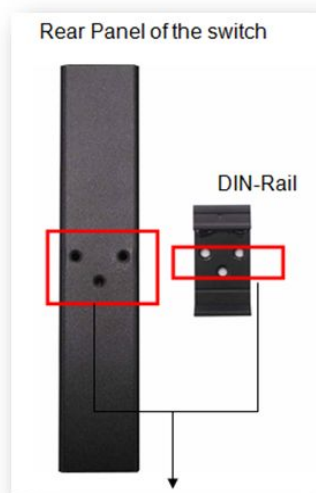

Figure 3.1 - Rear View of the Switch and DIN-Rail



Figure 3.2 - Insert the Switch on the DIN-Rail

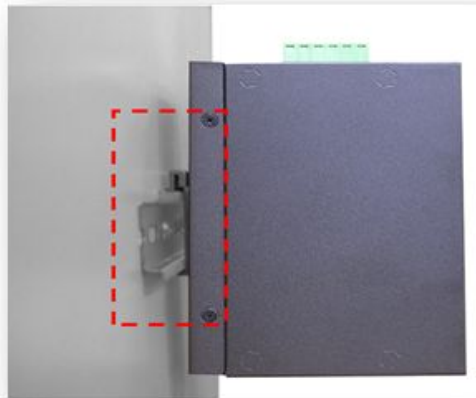

Figure 3.3 - Stable the Switch on the DIN-Rail

3.2 Wall Mounting

Follow the steps below to mount the industrial Ethernet switch using the wall mounting bracket as shown below in *Figure 3.4*.



Caution: “Wall” means industrial control panel wall



Attention: “Wall” signifie mur de panneau de commande industriel

1. Remove the DIN-Rail bracket from the industrial Ethernet switch by loosening the screws.
2. Place the wall mounting brackets on the top and bottom of the industrial Ethernet switch.
3. Use the screws to screw the wall mounting bracket on the industrial Ethernet switch.



Caution: The torque for tightening the screws on the device is 3.5 in-lbs.



Attention: Le couple de serrage des vis sur l'appareil est de 3.5 pouces-livres.

4. Use the hook holes at the corners of the wall mounting bracket to hang the industrial Ethernet switch on the wall.
5. To remove the wall mount bracket, do the opposite from the steps above.

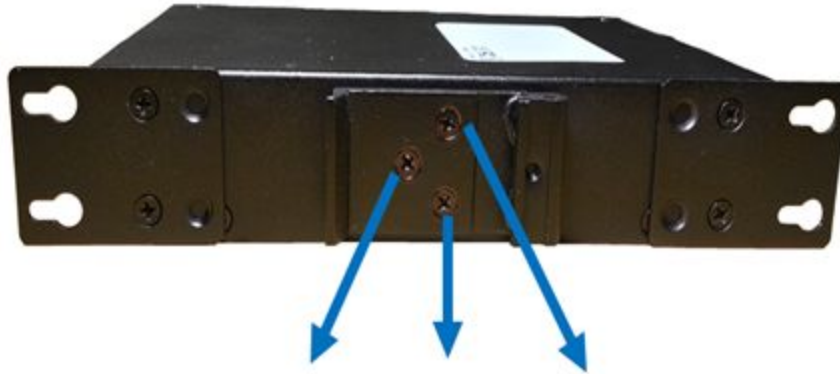

Figure 3.4 - Remove DIN-Rail bracket from the Switch

Below, in Figure 3.5 are the dimensions of the wall mounting bracket.

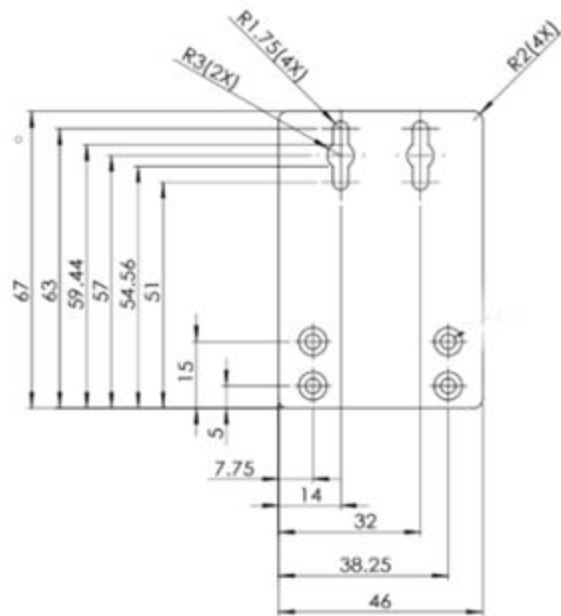

Figure 3.5 - Wall Mounting Bracket Dimensions

4 Hardware Installation

4.1 Installation Steps

This section will explain how to install the industrial Ethernet switch:



Caution: This device is intended for indoor use.



Attention: Cet appareil est destiné à une utilisation en intérieur.



Caution: The device is intended to be installed in an industrial control enclosure and panel.



Attention: L'appareil est destiné à être installé dans une armoire de commande et un panneau industriels.

Installation Steps

1. Unpack the industrial Ethernet switch from the original packing box.
2. Check if the DIN-Rail bracket is screwed on the industrial Ethernet switch.
 - If the DIN-Rail is not screwed on the industrial Ethernet switch, please refer to the **DIN-Rail Mounting** section for DIN-Rail installation.
 - If it is required to wall mount the industrial Ethernet switch, please refer to the **Wall Mounting** section for wall mounting installation.
3. To hang the industrial Ethernet switch on a DIN-Rail or wall, please refer to the **Mounting Installation** section.
4. Power on the industrial Ethernet switch and then the power LED light will turn on.
 - For the help on how to wire power, please refer to the **Wiring the Power Inputs** section.
 - Please refer to the **LED Indicators** section for LED light indication.
5. Prepare the twisted-pair, straight-through category 5 cable for Ethernet connection.
6. Insert one side of the RJ45 cable into the switch's Ethernet port and on the other side into the networking device's Ethernet port, e.g. switch PC or server.

- The Ethernet port's (RJ45) LED on the industrial Ethernet switch will turn on when the cable is connected to the networking device.
 - Please refer to the **LED Indicators** section for LED light indication.
7. When all connections are set and the LED lights all show normal, the installation is complete.

4.2 Maintenance and Service

- If the device requires servicing of any kind, the user is required to disconnect and remove it from its mounting. The initial installation should be done in a way that makes this as convenient as possible.
- Voltage / Power lines should be properly insulated as well as other cables. Be careful when handling them so as to not trip over.
- Do not under any circumstance insert foreign objects of any kind into the heat dissipation holes located in the different faces of the device. This may not only harm the internal layout, but might cause harm to users as well.
- Do not under any circumstance open the device for any reason. Please contact your dealer for any repair needed or follow the instructions within the manual.
- Clean the device with dry soft cloth.

4.3 Troubleshooting

- Always verify the right power cord or adapter is being used. Never use a power supply or adapter with a non-compliant DC output voltage or it will burn the equipment.
- Select the proper UTP or STP cable in order to construct the network. Use an unshielded twisted-pair (UTP) or shield twisted-pair (STP) cable for RJ45 connections: 100Ω Category 5e for 10/100Mbps. Also be sure that the length of any twisted-pair connection does not exceed 100 meters (328 feet).
- Diagnosing LED Indicators: To assist in identifying problems, the switch can be easily monitored with the LED indicators which help to identify if any problems exist.
 - Please refer to the LED Indicators section for LED light indication.
- If the power indicator LED does not turn on when the power cord is plugged in, the user may have a problem with the power cord. Check for loose power connections, power losses or surges at the power outlet.

- Please contact Antaira for technical support service if the problem still cannot be resolved.
- If the industrial switch LED indicators are normal and the connected cables are correct but the packets still cannot transmit, please check the system's Ethernet devices' configuration or status.

5 Technical Specifications

Table 5.1 has the technical specifications for this product series.

| Technology | |
|-----------------------------|---|
| L2 Switching | Port/MAC/Protocol/IP Subnet-based VLAN, GARP/GVRP, Loop Guard, Link Aggregation static/LACP, BPDU guard, Error disable recovery, IGMP snooping v2/v3, MLD snooping v1/v2, IGMP filtering, IPMC throttling / filtering leave proxy, DHCP snooping, G.8032 v1/v2 |
| L3 Switching | DHCP option82, static routes |
| QoS | 802.1p Queueing, Input priority mapping, Storm control for Unicast/Multicast/Broadcast, Port/Queue/ACL policer, Port egress shaper, Queue egress shaper, DiffServ (DSCP), Tag remarking, Scheduler mode |
| Power Saving | ActiPHY, PerfectReach, IEEE 802.3az EEE power management |
| Network Redundancy | STP/RSTP/MSTP, port trunk with LACP, ERPS v1/v2 (<50ms) |
| Configuration | Http, Https, Telnet, SSH, CLI, TFTP, SNMP v3 |
| System / Diagnostics | Dual Image Protection, PING, PING6 |
| Switch Properties | |
| Switch Architecture | Back-Plane (Switching Fabric): 24.0Gbps |
| Protocols | IPv4/IPv6, SNMP v1/v2c/v3, LLDP, LLDP-MED, HTTP, HTTPS, SSHv2 telnet, DHCP client, DHCPv6 client, DHCP server, Port Mirror, DNS client/proxy, IP based Access Filter, ICMPv6, syslog, Time Zone / Daylight Saving, NTP client, RMON, sFlow, Loop detection, Console Port, Power Lost Warning, Relay Trigger |
| Processing Type | Store and Forward |
| Flow Control | IEEE 802.3x for full duplex mode, back pressure for half duplex mode |
| Transfer Rate | 14,880pps for 10Base-T Ethernet 148,800pps for 100Base-T Fast Ethernet 1,488,000pps for Gigabit Ethernet |
| Packet Buffer | 4Mbits |
| Jumbo Frame | 9.6Kbytes |

Antaira Technologies - Industrial Ethernet Switch
LMX-1202G-SFP Series - Hardware Manual - v2.0

| | |
|------------------------------------|--|
| MAC Table Size | 8K |
| VLAN Group | 4095 |
| IGMP Group | 1024 |
| Port Interface | |
| Ethernet Port | 10*10/100/1000BaseTx Auto-negotiation speed, Full/Half duplex mode, and auto MDI/MDI-X connection |
| SFP Port | 2*100/1000 SFP slots |
| RS232 Serial Console | 1*RS232 in RJ45 connector with console cable, 115.2Kbps, 8, N, 1 |
| LED Indicators | System: Power 1, Power 2, Fault, Master, and Ring Ethernet Ports: Speed/Link/Active Fixed Fiber: Link/Active |
| Protection | |
| Network Cable | 10Base-T: 2-pair UTP/STP Cat. 3, 4, 5 cable; EIA/TIA-568 100-ohm (100m) 100Base-TX: 2-pair UTP/STP Cat. 5 cable; EIA/TIA-568 100-ohm (100m) 1000BaseTX: 4-pair UTP/STP Cat. 5/5E cable; EIA/TIA-568 100-ohm (100m) |
| Mechanical Characteristics | |
| Housing | Metal, IP30 protection |
| Dimensions | 54 x 142 x 99 mm (W x H x D) |
| Weight | Unit: 1.98 lbs. Shipping: 2.87 lbs. |
| Mounting | DIN-Rail mounting; Wall mounting |
| Power Requirement | |
| Input Voltage | 12~48VDC Redundant Input |
| Power Connection | 1 removable 6-contact terminal block |
| Relay Contact | 24VDC, 1A resistive |
| Overload Current Protection | Present |
| Reverse Polarity Protection | Present |

Antaira Technologies - Industrial Ethernet Switch
LMX-1202G-SFP Series - Hardware Manual - v2.0

| | |
|----------------------------------|---|
| System Power Consumption | 15 Watts |
| Environmental Limits | |
| Operating Temperature | STD: -10°C to 65°C EOT: -40°C to 75°C |
| Storage Temperature | -40°C ~ 85°C |
| Ambient Relative Humidity | 5 to 95%, (non-condensing) |
| Regulatory Approvals | |
| EMI | FCC Part 15 Subpart B Class A CE EN55032/EN61000-6-4 Class A |
| EMS | CE EN55024/EN61000-6-2 Class A EN61000-4-2,3,4,5,6,8 |
| Free Fall | IEC60068-2-32 |
| Shock | IEC60068-2-27 |
| Vibration | IEC60068-2-6 |
| Green | RoHS Compliant |
| Certifications | FCC, CE, UL 61010-1, 61010-2-201, ISA 12.12.01 Class 1 Division 2, ATEX II 3G Ex nA nC IIC T4 Gc, NEMA TS2 |
| Warranty | 5 Years |

Table 5.1 - Technical Specifications

Antaira Customer Service and Support

(Antaira US Headquarter) + 844-268-2472

(Antaira Europe Office) +48-22-862-88-81

(Antaira Asia Office) +886-2-2218-9733

Please report any problems to Antaira:

www.antaira.com / support@antaira.com

www.antaira.eu / info@antaira.eu

www.antaira.com.tw / info@antaira.com.tw

Any changes to this material will be announced on the Antaira website.